



## INSTRUCTION MANUAL

VHF TRANSCEIVER  
**IC-F50V**  
UHF TRANSCEIVER  
**IC-F60V**

This device complies with Part 15 of the FCC Rules. Operation is subject to the condition that this device does not cause harmful interference.

**icom Inc.**



---

# SAFETY TRAINING INFORMATION

---



**WARNING**

Your Icom radio generates RF electromagnetic energy during transmit mode. This radio is designed for and classified as “Occupational Use Only”, meaning it must be used only during the course of employment by individuals aware of the hazards, and the ways to minimize such hazards. This radio is NOT intended for use by the “General Population” in an uncontrolled environment.

This radio has been tested and complies with the FCC RF exposure limits for “Occupational Use Only”. In addition, your Icom radio complies with the following Standards and Guidelines with regard to RF energy and electromagnetic energy levels and evaluation of such levels for exposure to humans:

- FCC OET Bulletin 65 Edition 97-01 Supplement C, Evaluating Compliance with FCC Guidelines for Human Exposure to Radio Frequency Electromagnetic Fields.
- American National Standards Institute (C95.1-1992), IEEE Standard for Safety Levels with Respect to Human Exposure to Radio Frequency Electromagnetic Fields, 3 kHz to 300 GHz.
- American National Standards Institute (C95.3-1992), IEEE Recommended Practice for the Measurement of Potentially Hazardous Electromagnetic Fields— RF and Microwave.
- The following accessories are authorized for use with this product. Use of accessories other than those specified may result in RF exposure levels exceeding the FCC requirements for wireless RF exposure.; Belt Clip (MB-98), Rechargeable Li-Ion Battery Pack (BP-227), Alkaline Battery Case (BP-226) and Speaker-microphone (HM-168).



**CAUTION**

**To ensure that your exposure to RF electromagnetic energy is within the FCC allowable limits for occupational use, always adhere to the following guidelines:**

- 
- 
- **DO NOT** operate the radio without a proper antenna attached, as this may damaged the radio and may also cause you to exceed FCC RF exposure limits. A proper antenna is the antenna supplied with this radio by the manufacturer or antenna specifically authorized by the manufacturer for use with this radio.
  - **DO NOT** transmit for more than 50% of total radio use time (“50% duty cycle”). Transmitting more than 50% of the time can cause FCC RF exposure compliance requirements to be exceeded. The radio is transmitting when the “TX indicator” lights red. You can cause the radio to transmit by pressing the “PTT” switch.
  - **ALWAYS keep** the antenna at least 2.5 cm (1 inch) away from the body when transmitting and only use the Icom belt-clip which is listed on page 38 when attaching the radio to your belt, etc., to ensure FCC RF exposure compliance requirements are not exceeded. To provide the recipients of your transmission the best sound quality, hold the antenna at least 5 cm (2 inches) from your mouth, and slightly off to one side.

The information listed above provides the user with the information needed to make him or her aware of RF exposure, and what to do to assure that this radio operates with the FCC RF exposure limits of this radio.

### **Electromagnetic Interference/Compatibility**

During transmissions, your Icom radio generates RF energy that can possibly cause interference with other devices or systems. To avoid such interference, turn off the radio in areas where signs are posted to do so. **DO NOT** operate the transmitter in areas that are sensitive to electromagnetic radiation such as hospitals, aircraft, and blasting sites.

### **Occupational/Controlled Use**

The radio transmitter is used in situations in which persons are exposed as consequence of their employment provided those persons are fully aware of the potential for exposure and can exercise control over their exposure.

---

# IMPORTANT

---

**READ ALL INSTRUCTIONS** carefully and completely before using the transceiver.

**SAVE THIS INSTRUCTION MANUAL**— This instruction manual contains important operating instructions for the IC-F50V VHF TRANSCEIVER and IC-F60V UHF TRANSCEIVER.

---

## EXPLICIT DEFINITIONS

---

WORD	DEFINITION
<b>⚠ WARNING</b>	Personal injury, fire hazard or electric shock may occur.
<b>CAUTION</b>	Equipment damage may occur.
<b>NOTE</b>	If disregarded, inconvenience only. No risk of personal injury, fire or electric shock.

---

## OPERATING NOTES

---

- When transmitting with a portable radio, hold the radio in a vertical position with its microphone 5 to 10 cm (2 to 4 inches) away from your mouth. Keep the antenna at least 2.5 cm (1 inch) from your head and body.
- If you wear a portable two-way radio on your body, ensure that the antenna is at least 2.5 cm (1 inch) from your body when transmitting.

Icom, Icom Inc. and the  ICOM logo are registered trademarks of Icom Incorporated (Japan) in the United States, the United Kingdom, Germany, France, Spain, Russia and/or other countries.

---

# PRECAUTIONS

---

⚠ **WARNING! NEVER** hold the transceiver so that the antenna is very close to, or touching exposed parts of the body, especially the face or eyes, while transmitting. The transceiver will perform best if the microphone is 5 to 10 cm (2 to 4 inches) away from the lips and the transceiver is vertical.

⚠ **WARNING! NEVER** operate the transceiver with a headset or other audio accessories at high volume levels.

**CAUTION! NEVER** short the terminals of the battery pack.

**NEVER** connect the transceiver to a power source other than the BP-226 or BP-227. Such a connection will ruin the transceiver.

**DO NOT** push the PTT when not actually desiring to transmit.

**AVOID** using or placing the transceiver in direct sunlight or in areas with temperatures below  $-30^{\circ}\text{C}$  ( $-22^{\circ}\text{F}$ ) or above  $+60^{\circ}\text{C}$  ( $+140^{\circ}\text{F}$ ).

**DO NOT** modify the transceiver for any reason.

**DO NOT** operate the transceiver near unshielded electrical blasting caps or in an explosive atmosphere. The IC-F50V/F60V series transceivers are not the explosion-proof construction.

**MAKE SURE** the flexible antenna and battery pack are securely attached to the transceiver, and that the antenna and battery pack are dry before attachment. Exposing the inside of the transceiver to water will result in serious damage to the transceiver.

**BE CAREFUL!** The IC-F50V/F60V series transceivers employ waterproof construction, which corresponds to IPX7 of the international standard IEC 60529 (2001), 1 m depth for 30 minutes. However, once the transceiver has been dropped, waterproofing cannot be guaranteed due to the fact that the transceiver may be cracked, or the waterproof seal damaged, etc.

The use of non-Icom battery packs/chargers may impair transceiver performance and invalidate the warranty.

## ***FCC caution:***

Changes or modifications to this device, not expressly approved by Icom Inc., could void your authority to operate this transceiver under FCC regulations.

---

# TABLE OF CONTENTS

---

SAFETY TRAINING INFORMATION .....	i
IMPORTANT .....	iii
EXPLICIT DEFINITIONS .....	iii
OPERATING NOTES .....	iii
PRECAUTIONS .....	iv
TABLE OF CONTENTS .....	v
<b>1 ACCESSORIES .....</b>	<b>1-3</b>
■ Supplied accessories .....	1
■ Accessory attachments.....	2
<b>2 PANEL DESCRIPTION .....</b>	<b>4-13</b>
■ Front, top and side panels .....	4
■ Function display .....	6
■ Programmable function keys .....	8
<b>3 BASIC OPERATION.....</b>	<b>14-23</b>
■ Turning power ON .....	14
■ Channel selection .....	14
■ Call procedure .....	15
■ Receiving and transmitting .....	16
■ User set mode .....	20
■ Emergency transmission .....	21
■ Scrambler function .....	21
■ Stun function .....	21
■ Recording function (Depends on the version) .....	22
<b>4 BATTERY CHARGING .....</b>	<b>24-31</b>
■ Caution .....	24
■ Optional battery chargers .....	27
<b>5 BATTERY CASE .....</b>	<b>32-33</b>
■ Optional battery case (BP-226).....	32
<b>6 SPEAKER-MICROPHONE .....</b>	<b>34-35</b>
■ Optional HM-168 description .....	34
■ Attachment .....	35
<b>7 SWIVEL BELTCLIP .....</b>	<b>36-37</b>
■ Optional MB-86 contents .....	36
■ Attaching .....	36
■ Detaching .....	37
<b>8 OPTIONS .....</b>	<b>38-41</b>

# ACCESSORIES 1

## ■ Supplied accessories

1

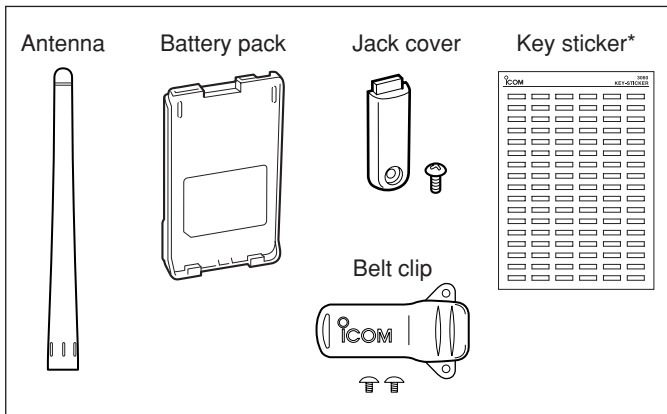

\*There are no names on the programmable function keys since the functions can be freely assigned to [P0] to [P3], [Red], [▼] and [▲] keys.

Attach the supplied key stickers above the appropriate keys for easy recognition of that key's assigned function.

## ■ Accessory attachments

### ◇ Flexible antenna

Connect the supplied flexible antenna to the antenna connector.

#### CAUTION!

- **NEVER HOLD** the antenna when carrying the transceiver.
- Transmitting without an antenna may damage the transceiver.

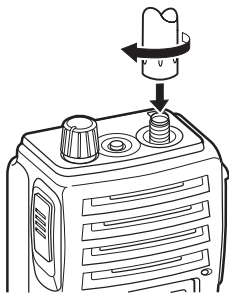

### ◇ Battery pack

#### *To attach the battery pack:*

Slide the battery pack on the back of the transceiver in the direction of the arrow (1), then lock it with the battery release button.

- Slide the battery pack until the battery release button makes a 'click' sound.

#### *To release the battery pack:*

Push the battery release button in the direction of the arrow (2) as shown below. The battery pack is then released.

- **NEVER** release or attach the battery pack when the transceiver is wet or soiled. This may result water or dust getting into the transceiver/battery pack and may result in the transceiver being damaged.

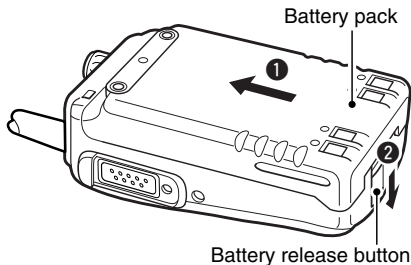

- **NOTE:** Keep the battery pack terminals clean. It's a good idea to clean the battery pack terminals once a week.



## ◇ Jack cover

Attach the jack cover when the optional equipment is not used.

### **To attach the jack cover:**

- ① Insert the jack cover into the [SP MIC] jack.
- ② Tighten the screw.

### **To detach the jack cover:**

- ③ Unscrew the screw using a phillips screwdriver.
- ④ Detach the jack cover for the optional equipment connection.

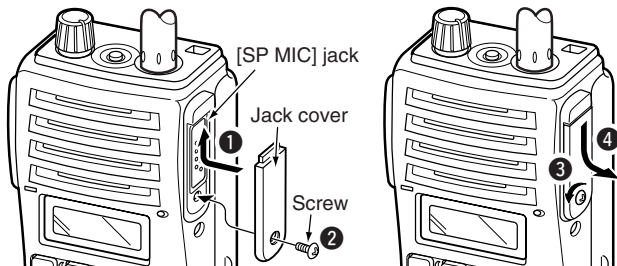

## ◇ Belt clip

Attach the belt clip to the back of the transceiver with the supplied screws.

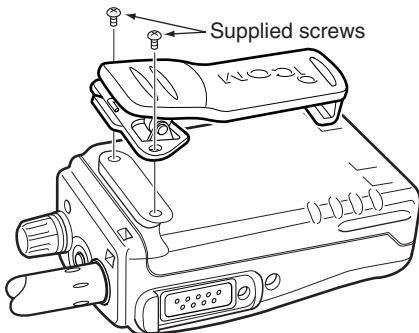

## 2 PANEL DESCRIPTION

### ■ Front, top and side panels

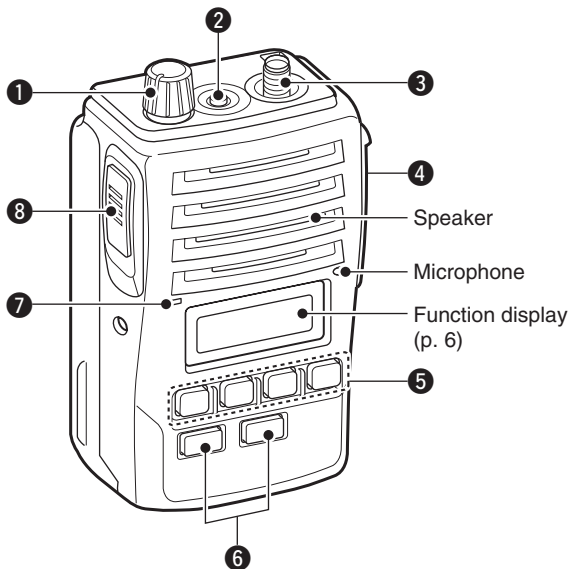

#### ① VOLUME CONTROL [VOL]

Turns power ON and adjusts the audio level.

#### ② RED BUTTON

The desired function can be assigned by your dealer. (p. 8)

#### ③ ANTENNA CONNECTOR

Connects the supplied antenna. (p. 2)

**4 EXTERNAL SPEAKER-MICROPHONE JACK [SP MIC]**

Connects the optional speaker-microphone, etc.

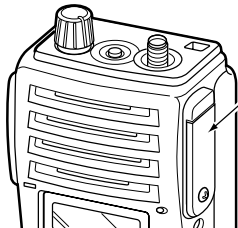

[SP MIC] jack cover

**NOTE:** KEEP the [SP MIC] jack cover attached to the transceiver when the optional equipment is not used.  
(See p. 3 for details)

**5 DEALER-PROGRAMMABLE KEYS [P0] to [P3]**

The desired functions can be assigned independently by your dealer. (p. 8)

**6 CH UP AND DOWN KEYS [▲]/[▼]**

Push to select an operating channel, etc.

\*Desired functions can be assigned independently by your dealer.  
(p. 8)

**7 TRANSMIT/BUSY INDICATOR**

Lights red while transmitting; lights green while receiving a signal, or when the squelch is open.

**8 PTT SWITCH [PTT]**

➡ Push and hold to transmit; release to receive.

➡ When the recording function is activated, TX voice message can be recorded while pushing and holding [PTT]. (p. 22)

### ■ Function display

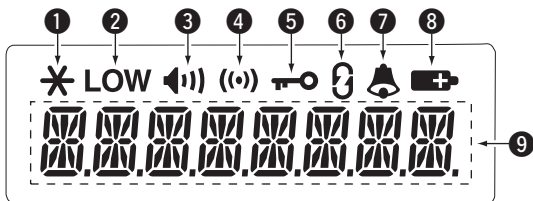

#### ① RECORD INDICATOR

- Appears when an unread message is in the memory.
- Blinks while recording.

#### ② LOW POWER INDICATOR

Appears when low output power is selected.

#### ③ AUDIBLE INDICATOR

- Appears when the channel is in the 'audible' (unmute) condition.
- Appears when the specified 2/5-tone/BIIS\*<sup>1</sup>/MDC\*<sup>2</sup> code is received.

#### ④ COMPANDER INDICATOR

Appears when the compander function is activated.

#### ⑤ KEY LOCK INDICATOR

Appears when the key lock function is activated.

#### ⑥ SCRAMBLER INDICATOR

Appears when the voice scrambler function is activated.

#### ⑦ BELL INDICATOR

Appears/blinks when the specific 2/5-tone/BIIS\*<sup>1</sup>/MDC\*<sup>2</sup> code is received, according to the pre-programming.

**8 BATTERY INDICATOR**

Appears or blinks when the battery power decreases to a specified level.

**9 ALPHANUMERIC DISPLAY**

Displays an operating channel number, channel names, Set mode contents, DTMF code, etc.

\*1 BIIS operation only

\*2 MDC operation only

### ■ Programmable function keys

The following functions can be assigned to [P0], [P1], [P2], [P3], [Red], [▼] and [▲] programmable function keys.

Consult your Icom dealer or system operator for details concerning your transceivers programming.

If the programmable function names are bracketed in the following explanations, the specific key is used to activate the function depends on programming.

#### **CH UP AND DOWN KEYS**

- Push to select an operating channel.
- Push to select a transmit code channel after pushing [TX Code CH Select].
- Push to select a DTMF channel after pushing [DTMF Autodial].
- Push to select a scan group after pushing and holding [Scan A Start/Stop]/[Scan B Start/Stop].

#### **ZONE SELECT KEY**

Push this key, then select the desired zone using [CH Up]/[CH Down].

/// **What is a “zone”?**—The desired channels are assigned into a zone according to the intended use for grouping. For example, ‘Staff A’ and ‘Staff B’ are assigned into a “Business” zone, and ‘John’ and ‘Cindy’ are assigned into a “Private” zone.

#### **SCAN A START/STOP KEY**

- This key’s operation depends on the Power ON Scan setting.
  - When the power ON scan function is turned OFF;**  
Push to start and cancel scanning operation.
  - When the power ON scan function is turned ON;**  
Push to pause scanning, then resumes scanning after a specified time period has passed.
- Push and hold this key for 1 sec. to indicate the scan group, then select the desired scan group using [CH Up]/[CH Down].

**SCAN B START/STOP KEY**

- Push to start and cancel scanning operation. Scan resumes after a specified time period has passed when scan is cancelled except for this key.
- Push and hold this key for 1 sec. to indicate the scan group, then select the desired scan group using [CH Up]/[CH Down].

**SCAN ADD/DEL (TAG) KEY**

- Push to add or delete the selected channel to/from the scan group.
  1. Push to indicate the scan group, then push [CH Up] or [CH Down] to select the desired group.
  2. Push to add or delete the channel to/from the selected scan group.
  3. Push and hold for 1 sec. to exit the scan group selection mode.
- Push this key while scan is paused (a signal is detected) on a channel (except for priority channel,) the channel is cleared from the scan group.

/// Depending on the setting, the cleared channel is added to the  
/// scan group again after the scan is cancelled. (Nuisance  
/// Delete function)

**PRIORITY CHANNEL KEYS**

- Push to select Priority A or Priority B channel.
- Push and hold [Prio A (Rewrite)] or [Prio B (Rewrite)] to set the operating channel as the Priority A or Priority B channel.

**MR-CH 1/2/3/4 KEYS**

Push to select the memory channel 1 to 4 directly.

**LOCK KEY**

Push and hold to toggle the key lock function ON or OFF.

- All programmable keys except the followings are electronically locked when the key lock function is activated: [PTT], [Light], [Lone Worker], [Surveillance], [Call] (incl. Call A and Call B), [Moni(Audi)] and [Emergency].

---

## 2 PANEL DESCRIPTION

### **MONITOR KEY**

- Mute and release the CTCSS (DTCS) or 2-tone squelch mute. Open any squelch/deactivate any mute while pushing and holding this key. (LMR operation only)
- Activates one of (or two of) the following functions on each channel independently: (PMR operation only)
  - Push and hold to un-mute the channel (audio is emitted; 'Audible' condition).
  - Push to mute the channel (sets to 'Inaudible' only).
  - Push after the communication is finished to send a 'reset code'. (BIIS operation only)

 **NOTE:** The un-mute condition ('Audible' condition) may automatically return to the mute condition ('Inaudible' condition) after a specified period.

### **LIGHT KEY**

Push to turn the backlight ON for about 5 sec. even if the backlight function is turned OFF in user set mode.

### **LONE WORKER KEY**

Push to turn the Lone Worker function ON or OFF.

- If the Lone Worker function is activated, the Emergency function is automatically turned ON after the specified time period has passed with no operation is performed.

### **HIGH/LOW KEY**

Push to select the transmit output power temporarily or permanently, depending on the pre-setting.

- Ask your dealer for the output power level for each selection.

### **C.TONE CHANNEL ENTER KEY**

Push to enter the continuous tone channel selection mode, and push [CH Up]/[CH Down] to change the tone frequency/code setting. The selected channel remains set as the continuous tone channel until another channel is designated as such.



**TALK AROUND KEY**

Push to turn the talk around function ON and OFF.

- The talk around function equalizes the transmit frequency to the receive frequency for transceiver-to-transceiver communication.

**WIDE/NARROW KEY**

Push to toggle the IF bandwidth between wide and narrow.

- The wide passband width can be selected from 25.0 or 20.0 kHz using the CS-F50V CLONING SOFTWARE. (PMR operation only) Ask your dealer for details.

**DTMF AUTODIAL KEY**

- Push to enter the DTMF channel selection mode. Then select the desired DTMF channel using [CH Up]/[CH Down].
- After selecting the DTMF channel, push again to transmit the selected DTMF code.

**DTMF RE-DIAL KEY**

Push to transmit the last-transmitted DTMF code.

- TX memories are cleared after turning the transceiver OFF.

**CALL KEYS**

Push to transmit a 2/5-tone/BIIS ID code.

- Call transmission is necessary before calling another station depending on your signalling system.
- [Call A] and/or [Call B] may be available when your system employs selective 'Individual/Group' calls. Ask your dealer which call is assigned to each key.

**SURVEILLANCE KEY**

Push to turn the surveillance function ON or OFF.

When this function is turned ON, the beep is not emitted and the LCD backlight and the LED indicator do not light when a signal is received or a key is pushed.

---

## 2 PANEL DESCRIPTION

### **EMERGENCY KEYS**

Push and hold to transmit the emergency call.

- The emergency call transmits with beeps; the display does not change.
- The transceiver can transmit the emergency call silently or with the display changes depending on the pre-setting. Ask your dealer for details.
- If you want to cancel the emergency call, push and hold the key again before transmitting the call.
- The emergency call is transmitted one time only or repeatedly until receiving a control code, depending on the pre-setting.

### **TX CODE ENTER KEY** (PMR operation only)

Push to enter the TX code edit mode. Then set the desired digit using [CH Up]/[CH Down]. (p. 19)

### **TX CODE CHANNEL SELECT KEY**

- ➡ Push to enter the TX code channel selection mode. Then select the desired channel using [CH Up]/[CH Down]. (p. 18)
- ➡ While in the TX code channel selection mode, push and hold for 1 sec. to enter the TX code edit mode. Then set the desired digit using [CH Up]/[CH Down]. (p. 19; PMR operation only)

### **TX CODE CHANNEL UP/DOWN KEYS**

Push to select a TX code channel directly.

### **ID-MR SELECT KEY** (PMR operation only)

- ➡ Recalls detected ID codes.
  - Push this key, then push [CH Up]/[CH Down] for selection.
  - Up to 5 ID's are memorized.
- ➡ Push and hold to erase the selected memorized ID's.

### **VOICE SCRAMBLER FUNCTION**

Push to turn the voice scrambler function ON and OFF.

**COMPANDER KEY**

Push to turn the compander function ON and OFF.

The compander function reduces noise components from the transmitting audio to provide clearer communication.

**USER SET MODE KEY**

- Push and hold to enter user set mode.
  - While in user set mode, push this key to select an item, and push [CH Up]/[CH Down] to change the value or condition.
- Push and hold this key again to exit user set mode.
  - User set mode is also available via the 'Power ON function'. Please refer to p. 20 also.

**PLAYBACK KEY** (p. 23)

- Push to playback the recorded messages in sequence, starting with the latest one.
  - A short beep is emitted after playing back each message.
  - A long beep is emitted after playing back all messages.
  - An error beep is emitted when there are no messages in the memory.
- While playing back the message, push and hold for 1 sec. to delete the selected message.

**PLAYBACK/REC KEY** (pgs. 22, 23)

- Push to playback the recorded messages in sequence, starting with the latest one.
  - A short beep is emitted after playing back each message.
  - A long beep is emitted after playing back all messages.
  - "NO REC" is displayed when no message is in the memory.
- Push and hold for 1 sec. to start recording. Push again to stop recording.
- While playing back the message, push and hold for 1 sec. to delete the selected message.

# 3 BASIC OPERATION

## ■ Turning power ON

- ① Rotate [VOL] to turn power ON.
  - When the opening vibration function is turned ON, the transceiver vibrates for 2 sec. Ask your dealer for details.
- ② If the transceiver is programmed for a start up passcode, input digit codes as directed by your dealer.
  - The keys in the table below can be used for password input:
  - The transceiver detects numbers in the same block as identical. Therefore “01234” and “56789” are the same.

KEY	P <sub>0</sub>	P <sub>1</sub>	P <sub>2</sub>	P <sub>3</sub>	▼ or ▲
NUMBER	0	1	2	3	4
	5	6	7	8	9

- ③ When the “PASSWORD” indication does not clear after inputting 4 digits, the input code number may be incorrect. Turn the power off and start over in this case.

## ■ Channel selection

Several types of channel selections are available. Methods may differ according to your system set up.

### **NON-ZONE TYPE:**

Push [CH Up]/[CH Down] to select the desired operating channel in sequence; or, push one of [MR-CH 1] to [MR-CH 4] to select a channel directly.

### **ZONE TYPE:**

Push [Zone] then push [CH Up]/[CH Down] to select the desired zone.

### **AUTOMATIC SCAN TYPE:**

Channel setting is not necessary for this type. When turning the power ON, the transceiver automatically starts scanning. Scanning stops when receiving a call.

## ■ Call procedure

When your system employs tone signalling (excluding CTCSS and DTCS), this call procedure may be necessary prior to voice transmission. The tone signalling employed may be a selective calling system which allows you to call specific station(s) only and prevent unwanted stations from contacting you.

- ① Select the desired TX code channel or 2/5-tone code according to your System Operator's instructions.
  - This may not be necessary depending on programming.
  - Refer to pgs. 18, 19 for selection.
- ② Push [Call] (assigned to one of the dealer programmable keys).
- ③ After transmitting, the remainder of your communication can be carried out in the normal fashion.

*Selective calling*

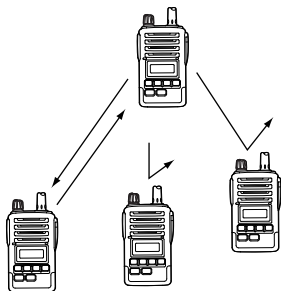

*Non-selective calling*

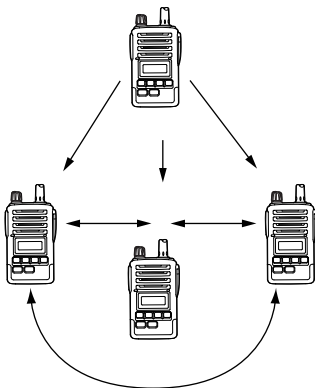

## ■ Receiving and transmitting

**NOTE:** Transmitting without an antenna may damage the transmitter. See p. 2 for antenna attachment.

### **Receiving:**

- ① Rotate [VOL] to turn power ON.
- ② Push [CH Up] or [CH Down] to select a channel.
- ③ When receiving a call, adjust the audio output level to a comfortable listening level.

### **Transmitting:**

Wait for the channel to become clear to avoid interference.

- ① While pushing and holding [PTT], speak into the microphone at a normal voice level.
  - When a tone signalling system is used, the call procedure described at the previous page may be necessary.
- ② Release [PTT] to return to receive.

**IMPORTANT:** To maximize the readability of your signal;

1. Pause briefly after pushing [PTT].
2. Hold the microphone 5 to 10 cm (2 to 4 inches) from your mouth, then speak into the microphone at a normal voice level.

## ◇ Receiving note

### • Vibration function (Depends on the version)

When the matched RX code signal is received, the transceiver may vibrate for a specified time period, depending on the pre-setting. Push any key or [PTT] to stop the vibration.

### NOTE:

- The transceiver cannot stop the vibration suddenly after pushing any key or [PTT].
- The vibration sound may be heard at the communication party, or be recorded if the recording function is activated when [PTT] is pushed to stop the vibration.

## ◇ Transmitting notes

### • Transmit inhibit function

The transceiver has several inhibit functions which restrict transmission under the following conditions:

- The channel is in mute condition ('Inaudible' condition; "⏸") does not appear).
- The channel is busy.
- Un-matched (or matched) CTCSS is received. (Depending on the pre-setting)
- The selected channel is a 'receive only' channel.

### • Time-out timer

After continuous transmission for the pre-programmed time period, the time-out timer starts, causing the transceiver to stop transmitting.

### • Penalty timer

Once the time-out timer starts, transmission is further inhibited for a period determined by the penalty timer.

#### ◇ TX code channel selection

If the transceiver has [TX Code CH Select] assigned to it, the indication can be toggled between the operating channel number (or name) and TX code channel number (or name). When the TX code channel number (or name) is displayed, [CH Up] or [CH Down] selects the TX code channel.

##### **USING [TX CODE CH SELECT] KEY:**

- ① Push [TX Code CH Select]— a TX code channel number (or name) appears.
- ② Push [CH Up] or [CH Down] to select the desired TX code channel.
- ③ After selecting, push [TX Code CH Select] to set.
  - Return to the stand-by mode.
- ④ Push [Call] to transmit the selected TX code.

##### **USING [TX CODE CH UP]/[TX CODE CH DOWN] KEY:**

If the transceiver has a [TX Code CH Up] or [TX Code CH Down] key assignment, the programmed TX code channel can be selected directly when pushed.

#### ◇ TX code number edit (PMR operation only)

If the transceiver has [TX Code CH Select] or [TX Code Enter] assigned to it, TX code contents can be edited within the allowable digits.

##### **USING [TX CODE CH SELECT] KEY:**

- ① Push [TX Code CH Select] to enter the TX code channel selection mode.
  - Select the desired operating channel before entering the TX code channel selection mode if necessary.
- ② Push [TX Code CH Select] for 1 sec. to enter the TX code edit mode.
  - The digit to be edited blinks.



- ③ Push [TX Code CH Select] to select the desired digit to be edited.
- ④ Push [CH Up]/[CH Down] to select the desired digit.
- ⑤ Push [TX Code CH Select] to set. The digit to the right will blink automatically.
- ⑥ Repeat ④ and ⑤ to edit all allowable digits.
- ⑦ After editing, push [TX Code CH Select] to set.
  - Return to the stand-by mode.
- ⑧ Push [Call] to transmit.

#### **USING [TX CODE ENTER] KEY:**

- ① After pushing [TX Code CH Select], push [CH Up] or [CH Down], or push [TX Code CH Up] or [TX Code CH Down] to select the desired TX code channel.
- ② Push [TX Code Enter] to enter the TX code edit mode.
  - The digit to be edited blinks.
- ③ Push [TX Code Enter] to select the desired digit to be edited.
- ④ Push [CH Up]/[CH Down] to select the desired digit.
- ⑤ Push [TX Code Enter] to set. The digit to the right will blink automatically.
- ⑥ Repeat ④ and ⑤ to edit all allowable digits.
- ⑦ After editing, push [TX Code Enter] to set.
  - Return to the stand-by mode.
- ⑧ Push [Call] to transmit.

#### **◇ DTMF transmission**

If the transceiver has [DTMF Autodial] assigned to it, the automatic DTMF transmission function is available. Up to 8 DTMF channels are available.

- ① Push [DTMF Autodial]— a DTMF channel appears.
- ② Push [CH Up] or [CH Down] to select the desired DTMF channel.
- ③ Push [DTMF Autodial] to transmit the DTMF code to the selected DTMF channel.

## ■ User set mode

User set mode is accessed at power ON and allows you to set seldom-changed settings. You can “customize” the transceiver operation to suit your preferences and operating style.

### *Entering the user set mode:*

- ① While pushing and holding [▼] and [▲], rotate [VOL] to power ON.
    - Turn power OFF in advance.
    - “SET MODE” appears for 1 sec.
  - ② Push and hold [P0] for 1 sec. to enter user set mode.
  - ③ Push [P0] momentarily to select the appropriate item.  
Then push [▼] or [▲] to set the desired level/condition.
    - Available set mode functions are **Backlight**, **Beep**, **SQL Level**, **Ringer Level**, **AF Min level**, **Mic Gain**, **VOX Gain\***, **VOX Delay\***, **Battery Voltage**, **Signal Moni**, **Vibration** and **Lone Worker**.
  - ④ Push and hold [P0] again to exit set mode.
- \* Appears when the optional headset is connected.

User set mode is also available using a programmable key. Please refer to p. 13 [User Set Mode] section for instructions regarding using the key assigned for user set mode.

/// **NOTE:** [▼], [▲] and [P0] activate while in the user set mode regardless of the assigned key functions.

## ■ Emergency transmission

When [Emergency] is pushed for the specified time period, an emergency signal is automatically transmitted.

When [Emergency] is pushed for the specified time period, the DTMF emergency signal is transmitted once or repeatedly on the emergency channel. However, when no emergency channel is specified, the signal is transmitted on the previously selected channel.

If you want to cancel the emergency call, push and hold the key again before transmitting the call.

## ■ Scrambler function

The scrambler function provides private communication between stations with the same scrambler codes.

- ① Push [Scrambler] to turn the scrambler function ON.
  - “G” appears.
- ② Push [Scrambler] again to turn the scrambler function OFF.

## ■ Stun function

When the specified ID, set as a kill key, is received, the stun function is activated.

When the kill ID is received, the transceiver switches to the password required condition. Entering of the password via the keypad is necessary to operate the transceiver again in this case.

## ■ Recording function (Depends on the version)

The transceiver has a recording function that records the TX/RX voice messages. When the specified ID is received, the automatic recording function activates and records the voice message for a specified time period.

Or, if the transceiver has [Playback/Rec] assigned to it, manual recording is also available.

The maximum record length is 480 sec., and the number of recordable messages depend on the record length. Ask your dealer for details.

e.g. When the record length is 10 sec., 48 messages are recordable.

### ***Automatic recording:***

- ① When the specified ID is received, the recording function is automatically activated.
  - “✱” blinks.
- ② While pushing and holding [PTT], speak into the microphone at a normal voice level.
  - The TX voice message is recorded.
- ③ Release [PTT] to receive.
  - The RX voice message is recorded.
- ④ The recording operation automatically stops after the following: the specified time has expired, the recording memory is full, pushing any key but [PTT], or transmitting a single tone.
  - “✱” stops blinking.
  - Pushing [Playback/Rec] (if assigned) also stops recording.

### ***Manual recording:***

- ① Push and hold [Playback/Rec] for 1 sec. to activate the recording function.
  - “✱” blinks.
- ② While pushing and holding [PTT], speak into the microphone at a normal voice level.
  - The TX voice message is recorded.

- ③ Release [PTT] to receive.
  - The RX voice message is recorded.
- ④ Push [Playback/Rec] again to stop recording.
  - “✱” stops blinking.
  - The recording operation automatically stops after the following: the recording memory is full, pushing any key but [PTT], or transmitting a single tone.

### ***Playing back:***

The recorded voice messages are played back with [Playback] or [Playback/Rec].

- “✱” appears on the function display when the unplayed message is in the recording memory.
- ➡ Push [Playback] or [Playback/Rec] to playback the recorded message in sequence starting with the latest one.
  - Push [CH Up] or [CH Down] to select the desired message.
  - A short beep is emitted after playing back each message.
  - A long beep is emitted after playing back all messages.
  - During playback mode, “✱” appears when the unplayed message is played back, or “✱” disappears when the played message is played back.
  - “✱” disappears after playing back the unplayed message for the specified time period.

 **NOTE:** You can transmit the recording message with [PTT] while playing back the message.

### ***Deleting the message:***

- ➡ While playing back the message, push and hold [Playback] or [Playback/Rec] for 1 sec. to delete the playing back message.
- ➡ While pushing and holding [P0] and [CH Up], turn power ON to delete all messages in the recording memory.

# 4 BATTERY CHARGING

## ■ Caution

Misuse of Lithium-Ion batteries may result in the following hazards: smoke, fire, or the battery may rupture. Misuse can also cause damage to the battery or degradation of battery performance.

⚠ **DANGER!** Use and charge only specified Icom battery packs with Icom radios or Icom charger. Only Icom battery packs are tested and approved for use and charge with Icom radios or Icom charger. Using third-party or counterfeit battery packs or charger may cause smoke, fire, or cause the battery to burst.

### ◇ Battery caution

⚠ **DANGER! DO NOT** hammer or otherwise impact the battery. Do not use the battery if it has been severely impacted or dropped, or if the battery has been subjected to heavy pressure. Battery damage may not be visible on the outside of the case. Even if the surface of the battery does not show cracks or any other damage, the cells inside the battery may rupture or catch fire.

⚠ **DANGER! NEVER** use or leave battery packs in areas with temperatures above +60°C (+140°F). High temperature buildup in the battery, such as could occur near fires or stoves, inside a sun heated car, or in direct sunlight may cause the battery to rupture or catch fire. Excessive temperatures may also degrade battery performance or shorten battery life.

⚠ **DANGER! DO NOT** expose the battery to rain, snow, seawater, or any other liquids. Do not charge or use a wet battery. If the battery gets wet, be sure to wipe it dry before using. The battery is not waterproof.

⚠ **DANGER! NEVER** incinerate used battery packs since internal battery gas may cause them to rupture, or may cause an explosion.

⚠ **DANGER! NEVER** solder the battery terminals or NEVER modify the battery pack. This may cause heat generation, and the battery may rupture, emit smoke or catch fire.

⚠ **DANGER!** Use the battery only with the transceiver for which it is specified. Never use a battery with any other equipment, or for any purpose that is not specified in this instruction manual.

⚠ **DANGER!** If fluid from inside the battery gets in your eyes, blindness can result. Rinse your eyes with clean water, without rubbing them, and see a doctor immediately.

**WARNING!** Immediately stop using the battery if it emits an abnormal odor, heats up, or is discolored or deformed. If any of these conditions occur, contact your Icom dealer or distributor.

**WARNING!** Immediately wash, using clean water, any part of the body that comes into contact with fluid from inside the battery.

**WARNING! NEVER** put the battery in a microwave oven, high-pressure container, or in an induction heating cooker. This could cause a fire, overheating, or cause the battery to rupture.

**CAUTION!** Always use the battery within the specified temperature range for the transceiver ( $-30^{\circ}\text{C}$  to  $+60^{\circ}\text{C}$ ;  $-22^{\circ}\text{F}$  to  $+140^{\circ}\text{F}$ ) and the battery itself ( $-10^{\circ}\text{C}$  to  $+60^{\circ}\text{C}$ ;  $14^{\circ}\text{F}$  to  $+140^{\circ}\text{F}$ ). Using the battery out of its specified temperature range will reduce the battery's performance and battery life. Please note that the specified temperature range of the battery may exceed that of the transceiver. In such cases, the transceiver may not work properly because it is out of its operating temperature range.

**CAUTION!** Shorter battery life could occur if the battery is left fully charged, completely discharged, or in an excessive temperature environment (above  $+45^{\circ}\text{C}$ ;  $+113^{\circ}\text{F}$ ) for an extended period of time. If the battery must be left unused for a long time, it must be detached from the radio after discharging. You may use the battery until the remaining capacity is about half, then keep it safely in a cool dry place with the temperature between  $-20^{\circ}\text{C}$  to  $+35^{\circ}\text{C}$  ( $-4^{\circ}\text{F}$  to  $+95^{\circ}\text{F}$ ).

### ◇ Charging caution

⚠ **DANGER! NEVER** charge the battery pack in areas with extremely high temperatures, such as near fires or stoves, inside a sun heated car, or in direct sunlight. In such environments, the safety/protection circuit in the battery will activate, causing the battery to stop charging.

**WARNING! DO NOT** charge or leave the battery in the battery charger beyond the specified time for charging. If the battery is not completely charged by the specified time, stop charging and remove the battery from the battery charger. Continuing to charge the battery beyond the specified time limit may cause a fire, overheating, or the battery may rupture.

**WARNING! NEVER** insert the transceiver (battery attached to the transceiver) into the charger if it is wet or soiled. This could corrode the battery charger terminals or damage the charger. The charger is not waterproof.

**CAUTION! DO NOT** charge the battery outside of the specified temperature range: 0°C to +45°C; +32°F to +113°F. Icom recommends charging the battery at +20°C (+68°F). The battery may heat up or rupture if charged out of the specified temperature range. Additionally, battery performance or battery life may be reduced.



## ■ Optional battery chargers

### ◇ Regular charging with the BC-152

- ① Attach the BC-152 to a flat surface, such as a desk, if desired.
- ② Connect the AC adapter (BC-147) as shown below.
- ③ Insert the battery pack with/without the transceiver into the charger.
  - The charge indicator lights green.
- ④ Charge the battery pack approx. 9–10 hours, depending on the remaining power condition.
  - The charge indicator goes off when charging is completed.

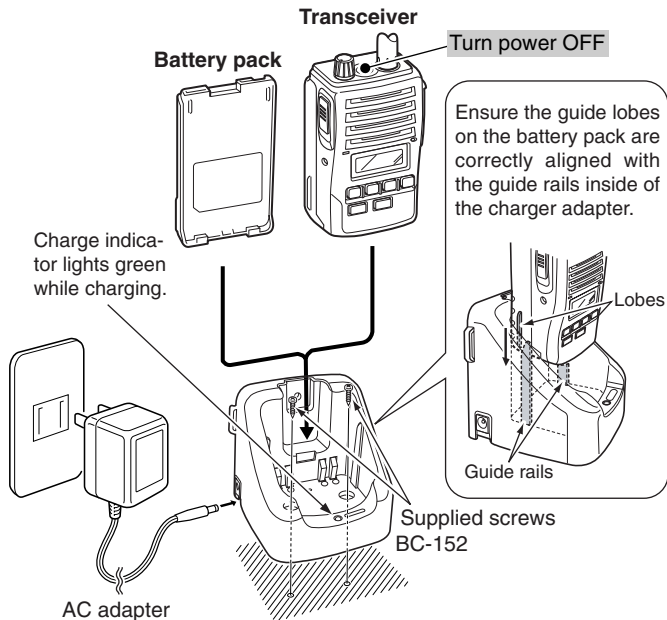

---

## 4 BATTERY CHARGING

### ◇ For your convenience

**Eyelet** →  
USE a rubber band to  
secure the transceiver  
while charging, if  
desired.

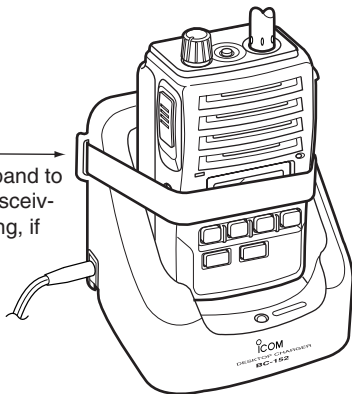

## ◇ AD-100 installation

The AD-100 CHARGER ADAPTER must be installed into the BC-119N or BC-121N before battery charging.

- Connect the AD-100 CHARGER ADAPTER and the BC-119N/BC-121N as below, then install the AD-100 into the holder space of the BC-119N or BC-121N with the supplied screws.

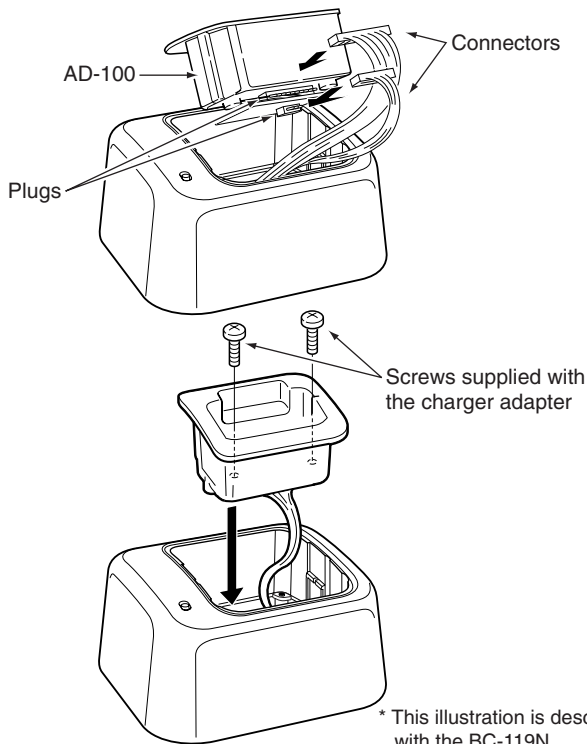

\* This illustration is described with the BC-119N.

## 4 BATTERY CHARGING

### ◇ Rapid charging with the BC-119N+AD-100

The optional BC-119N provides rapid charging of the optional Li-Ion battery pack. The following items are additionally required:

- An AD-100 charger adapter
- An AC adapter (may be supplied with BC-119N depending on version) or the DC power cable (OPC-515L/CP-17L).

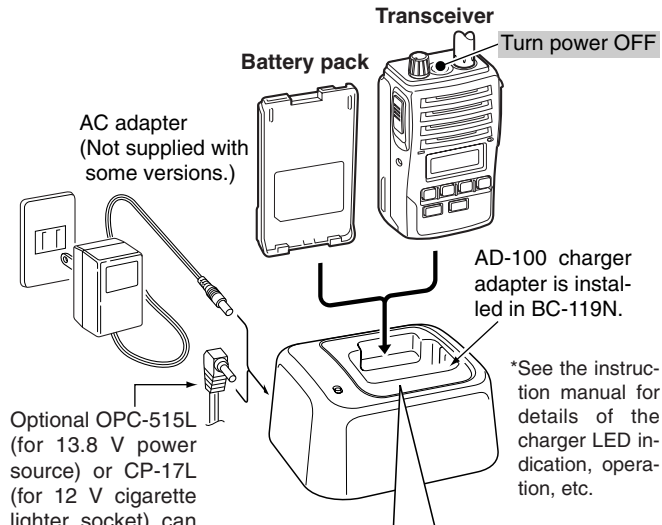

#### **IMPORTANT!:**

Ensure the guide lobes on the battery pack are correctly aligned with the guide rails inside of the charger adapter.

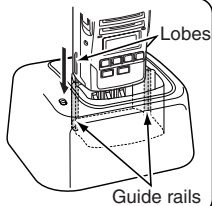

## ◇ Rapid charging with the BC-121N+AD-100

The optional BC-121N allows up to 6 battery packs to be charged simultaneously. The following items are additionally required.

- Six AD-100 charger adapter
- An AC adapter (BC-157) or the DC power cable (OPC-656)

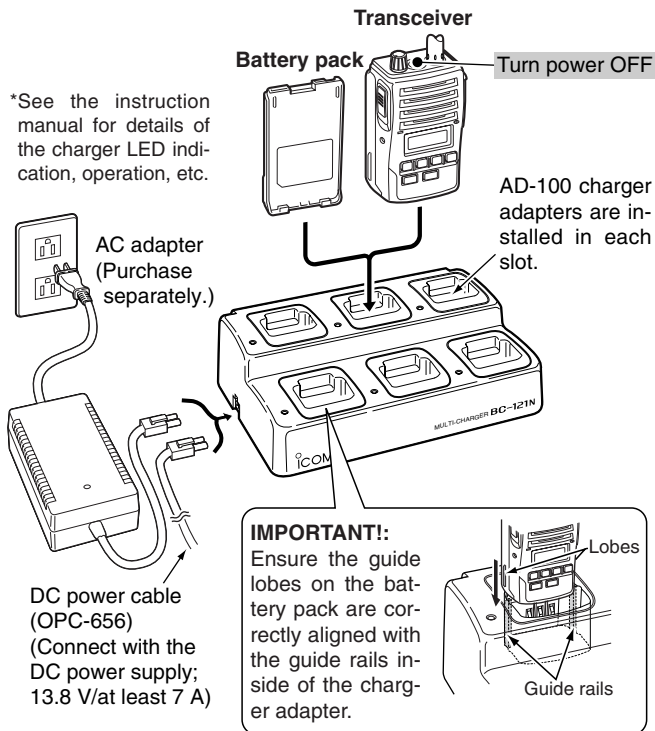

# 5 BATTERY CASE

## ■ Optional battery case (BP-226)

When using the optional battery case attached to the transceiver, install 5 × AA (LR6) size alkaline batteries as illustrated at right. The BP-226 is constructed to the IPX4 waterproof standard (IEC 60529, 2006).

- ① Hook your finger under the latch, and open the cover in the direction of the arrow (①). (Fig.1)
- ② Install 5 × AA (LR6) size alkaline batteries. (Fig.2)
  - Install the alkaline batteries only.
  - Be sure to observe the correct polarity.
  - Do not pin the ribbon under the batteries.
- ③ Close the cover by fitting in the direction of the arrow (②) first, then check that the latch is in place (③). (Fig.1)
  - Be sure the gasket and the ribbon are seated correctly, and do not protrude from the battery case. (Fig.3)

### CAUTION:

- When installing batteries, make sure they are all the same brand, type and capacity. Also, do not mix new and old batteries together.
- Keep battery contacts clean. It's a good idea to clean battery terminals once a week.
- Never incinerate used battery cells since internal battery gas may cause them to rupture.
- Never expose a detached battery case to water. If the battery case gets wet, be sure to wipe it dry before using it.

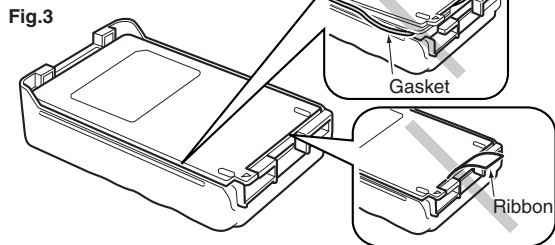
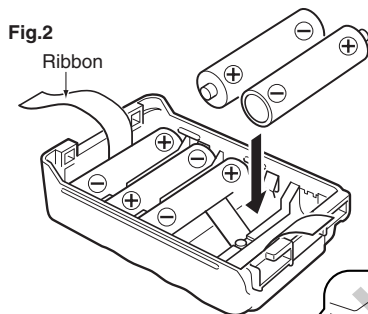
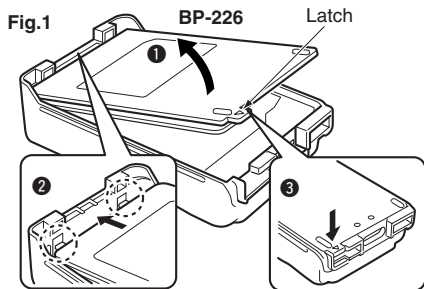

# 6 SPEAKER-MICROPHONE

## ■ Optional HM-168 description

### Alligator type clip

To attach the speaker-mic.  
to your shirt or collar, etc.

### PTT switch

Transmits while pushed  
Receives while released

### Microphone

### Speaker

Turn the transceiver power OFF  
when connecting the HM-168.

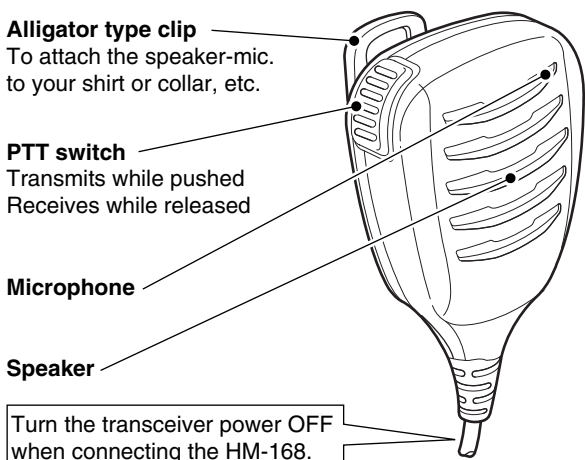

**NEVER** immerse the connector in water. If the connector becomes wet, be sure to dry it **BEFORE** attaching it to the transceiver.

**NOTE:** The microphone is located at the top of the speaker-microphone, as shown in the diagram above. To maximize the readability of your transmitted signal (voice), hold the microphone approx. 5 to 10 cm (2 to 4 inches) from your mouth, and speak in a normal voice level.



## ■ Attachment

Attach the connector of the speaker-microphone into the [SP MIC] jack on the transceiver and tighten the screw.

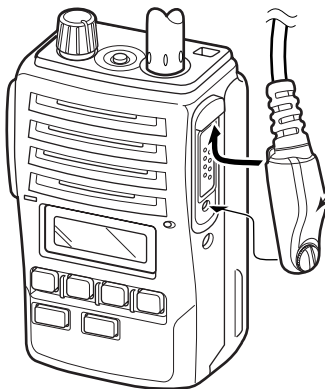

**CAUTION:** Attach the [SP MIC] jack snugly, but do not overtighten.

A loose connection will allow water intrusion into the jack; an overtightened jack will damage the connector pins in the transceiver.

**IMPORTANT:** KEEP the [SP MIC] jack cover attached to the transceiver when the speaker-microphone is not in use. (p. 3)  
Water will not get into the transceiver even if the cover is not attached, however, the terminals (pins) will become rusty, or the transceiver will function abnormally if the connector becomes wet.

# 7 SWIVEL BELT CLIP

## ■ Optional MB-86 contents

	Qty.
① Belt clip .....	1
② Base clip .....	1
③ Screws .....	2

## ■ Attaching

- ① Attach the base clip to the back of the transceiver.

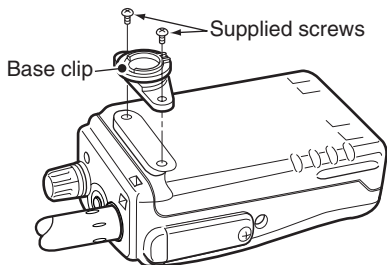

- ② Clip the belt clip to a part of your belt and insert the base clip into the belt clip.

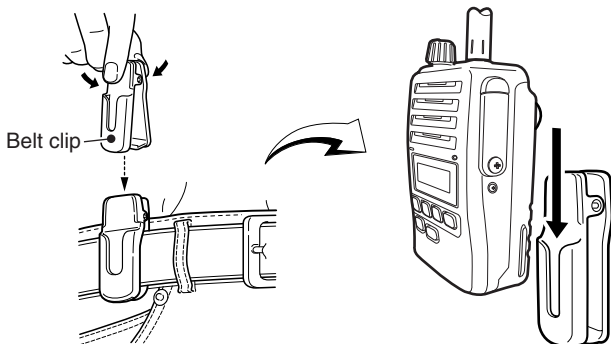

- ③ Once the transceiver is locked in place, it will swivel 360 degrees.

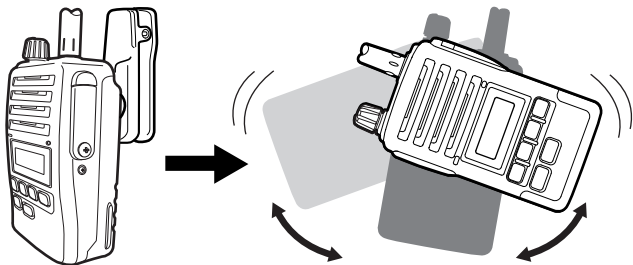

7

## ■ Detaching

Turn the transceiver upside down, and pull out from the belt clip. Then detach the base clip from the back of the transceiver.

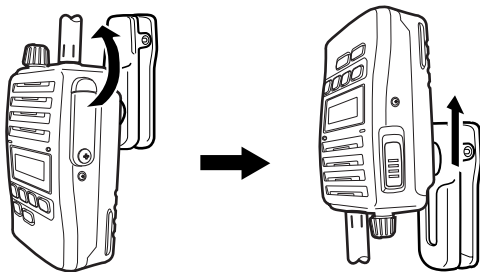

**CAUTION!**  
**HOLD THE TRANSCEIVER TIGHTLY WHEN ATTACHING OR DETACHING THE TRANSCEIVER FROM THE BELT CLIP.**  
 Otherwise the transceiver may not be attached to the holder, or may not swivel properly if the transceiver is accidentally dropped and the base clip is scratched or damaged.

# 8 OPTIONS

## ◇ BATTERY PACK/CASE

- **BP-226** BATTERY CASE

Battery case for 5 × AA (LR6) alkaline cells.

- **BP-227** Li-Ion BATTERY PACK

7.2 V/1700 mAh Li-Ion battery pack. The same as supplied with the transceiver. BP-227 must be charged with the optional BC-152/BC-119N/BC-121N.

## ◇ CHARGERS

- **BC-152** DESKTOP CHARGER + **BC-147** AC ADAPTER

Used for regular charging of the battery pack. The AC adapter, BC-147, must be purchased separately.

Charging time: approx. 9–10 hours for BP-227.

- **BC-119N** DESKTOP CHARGER + **AD-100** CHARGER ADAPTER + **BC-145** AC ADAPTER

For rapid charging of battery packs. An AC adapter is not supplied with some versions.

Charging time: approx. 2 to 2.5 hours for BP-227.

- **BC-121N** MULTI-CHARGER + **AD-100** CHARGER ADAPTER (6 pcs.) + **BC-157** AC ADAPTER

For rapid charging of up to 6 battery packs (six AD-100's are required) simultaneously. An AC adapter should be purchased separately.

Charging time: approx. 2 to 2.5 hours for BP-227.

## ◇ BELT CLIPS

- **MB-86** SWIVEL BELT CLIP

- **MB-98** BELT CLIP

Exclusive alligator-type belt clip. The same as supplied with the transceiver.

- **MB-96N/MB-96F** LEATHER BELT HANGERS

## ◇ DC CABLES

- **CP-17L** CIGARETTE LIGHTER CABLE

Allows charging of the battery pack through a 12 V cigarette lighter socket. (For BC-152/BC-119N)

- **OPC-515L/OPC-656** DC POWER CABLES

Allows charging of the battery pack using a 13.8 V power source instead of the AC adapter.

OPC-515L : For BC-152/BC-119N

OPC-656 : For BC-121N

## ◇ OTHER OPTIONS

- **HM-138/HM-168** SPEAKER-MICROPHONES

Full-sized waterproof (IPX7 waterproof protection) speaker-microphones including alligator type clip to attach to your shirt or collar, etc.

- **HS-94/HS-95/HS-97** HEADSET + **VS-1SC** VOX/PTT CASE

HS-94 : Ear-hook type

HS-95 : Neck-arm type

HS-97 : Throat microphone

VS-1SC : VOX/PTT switch box for hands-free operation, etc.

These items have IPX4 waterproof protection. When in use, the transceiver's waterproof rating meets IPX4 when they are connected.

- **OPC-966/966U** INTERFACE CABLE

Provides advanced operation, such as printer, GPS connection for position data transmission capabilities during BIIS operation.

- **FA-S62VS/FA-S63VS/FA-S57US** STUBBY ANTENNAS

FA-S62VS: 150–162 MHz FA-S63VS: 160–174 MHz

FA-S57US: 450–490 MHz

- **FA-S24V/FA-S59V/FA-S27U/FA-S56U/FA-S74U** ANTENNAS

FA-S24V: 136–150 MHz FA-S59V: 150–174 MHz

FA-S27U: 400–470 MHz FA-S56U: 450–520 MHz

FA-S74U: 490–520 MHz

Some options may not available in some countries. Please ask your dealer for details.

### ◆ About VS-1SC VOX/PTT CASE

The VS-1SC is a VOX/PTT unit for Icom handheld transceivers, and allows you hands-free operation.

An optional headset (HS-94, etc.) is required for operation.

- The VOX (Voice Operated Transmission) function starts transmission without pushing PTT switch when you speak into the microphone; then, automatically returns to receive when you stop speaking.

#### **Features**

- Equipped with a 9-pin Spring-plug type head SP/MIC plug is equipped
- Water resistant, durable construction
- Equipped with a PTT switch and revolving clip

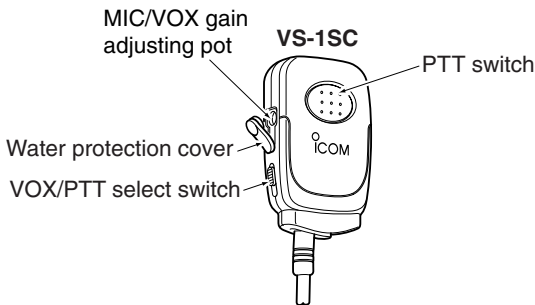

**VOX gain and delay adjustment**

- ① Attach the connector of the VS-1SC into the [SP/MIC] connector on the transceiver and tighten the screw.
  - Toggle the toggle switch to [VOX].
- ② Enter user set mode. (pgs. 13, 20)
- ③ Push [P0] several times to select “VOX Gain” or “VOX Delay.” Then, push [▼] or [▲] to set the desired level/condition.
- ④ Rotate [VOL] to turn the power OFF to exit set mode.

**• VOX Gain**

The VOX sensitivity level can be adjusted from OFF, or 1 through 6 for greater sensitivity.



VOX gain level is 3 (default)

**• VOX Delay**

The VOX delay time can be set from 0.5 to 3.0 sec. (in 0.5 sec. steps) to set the interval before returning to receive.

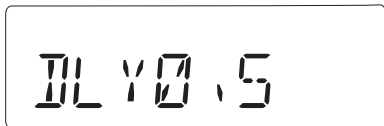

VOX delay timer is 0.5 sec. (default)

**NOTE:** MIC/VOX gain can be adjusted by the adjusting pot using a thin screw driver.

**Count on us!**

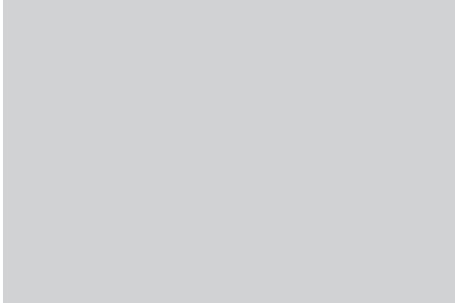

A-6604H-1EX  
Printed in Japan  
© 2007 Icom Inc.

Printed on recycled paper with soy ink.

**Icom Inc.**

1-1-32 Kamiminami, Hirano-ku, Osaka 547-0003, Japan

---